



Quick installation

Masterlink BTM-III

1  This section provides a brief overview of a basic installation of the Masterlink BTM-III.

However; please review the entire manual for connection of additional features and to ensure best performance and years of trouble-free service.

2  The electrical system must be disconnected from any power source during the entire installation! Use isolated tools!

 Read safety instructions (chapter 2 of the user's manual)

3 Connect the Masterlink BTM III as indicated below, but do not place the 2A-T fuses of the voltage sense wires yet!

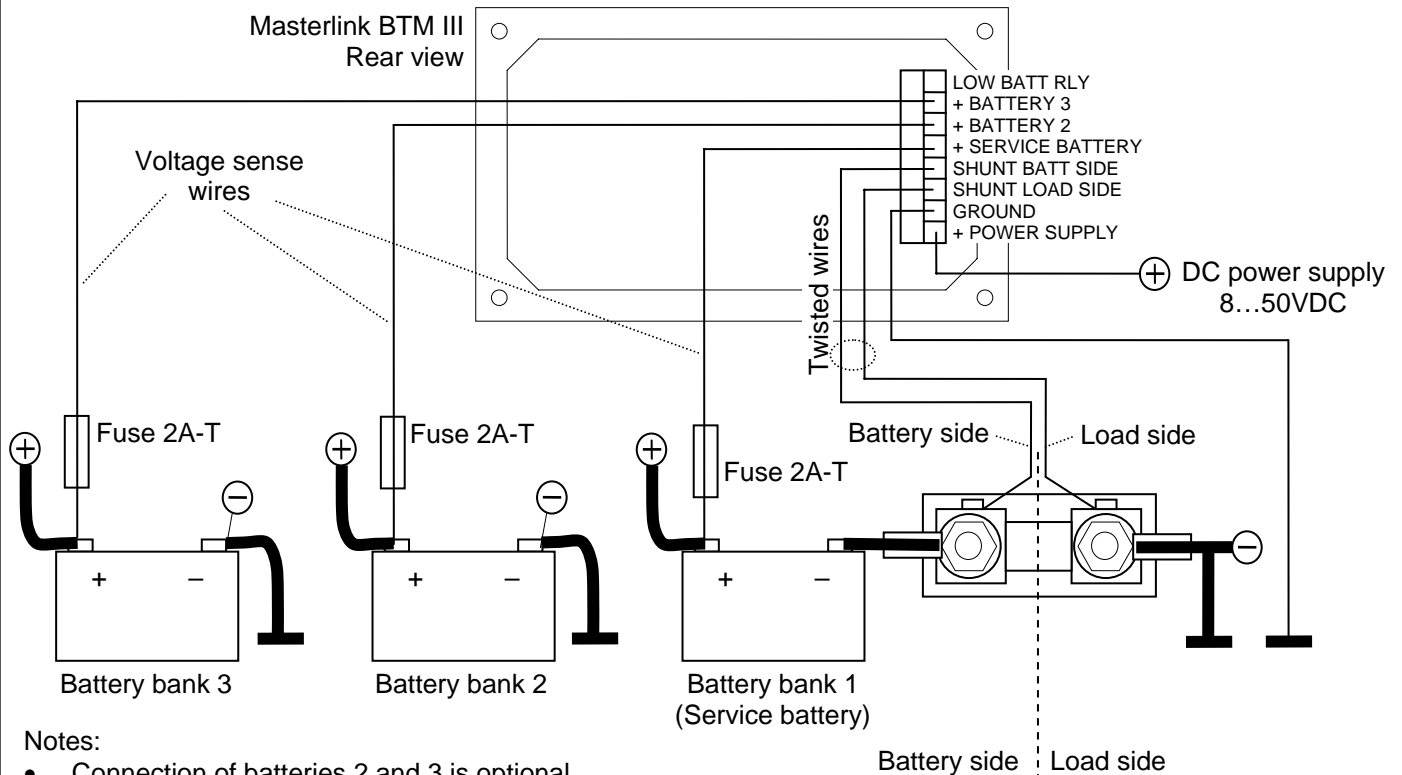

Notes:

- Connection of batteries 2 and 3 is optional
- Keep all wires as short as possible
- Keep wiring away from other noise producing conductors
- Take adequate measures to avoid corrosion of the wires and connections
- Do not exchange the wiring of the load side with the battery side
- Use twisted wires for current sensing wires
- Make sure that all minus cables of the electrical installation are connected at the load side of the shunt

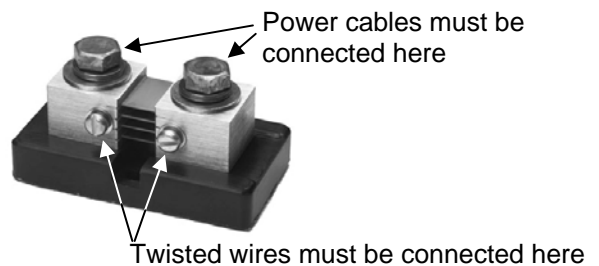

4 Check all wiring.
If the wiring is OK:

- Install the 2 A-T fuses of the voltage sense wires
- Place all battery fuses.



After a few seconds the display of the Masterlink BTM-III will show data. If not, immediately switch off the DC power supply and remove the fuses. Investigate the cause of the malfunctioning

5 

Next:

- The desired language must be set
- The Masterlink BTM-III must be synchronized in accordance with the electrical installation

Follow all steps as described in chapter 5 "FIRST START-UP" of the User's manual

The **Masterlink BTM-III** is the fuel gauge for up to three battery banks

The **LED bar** shows how full the main battery set is (bank 1): each LED represents 16% of the total capacity.

This **green LED** indicates that the main batteries are full (96-100% State Of Charge).

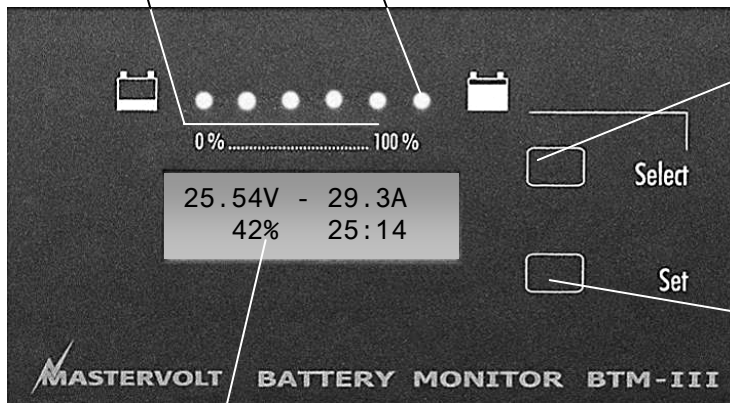

Use **Select** shortly to scroll through the menus
If you hold **Select** pressed for approximately 3 seconds, several advanced **Submenus** can be entered (see below)

Use **Set** for adjustments

The **Main menu** (chapter 6) provides a quick status overview of your batteries. Just press **Select** shortly to scroll.

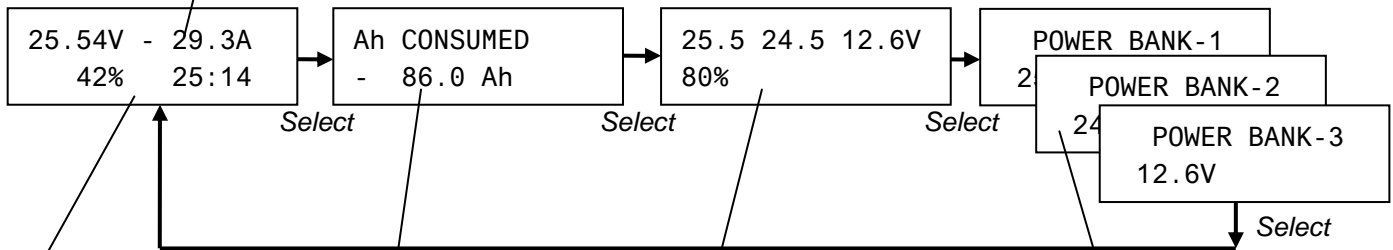

This screen is displayed by default.
It shows the voltage (Volt), current (Amps), state of charge (%) and time-to-go (hrs:min) of the main battery (battery bank 1)

Press **Select** shortly.
The next screen shows the actual capacity consumed from the main battery (battery bank 1)

Press **Select** again for a quick status overview of all battery banks simultaneously.
It shows the Battery voltage of all battery banks and the State Of Charge (SOC)

Press **Select** several times to show the actual data of each battery bank individually

If you hold **Select** pressed for approximately 3 seconds, several advanced **Submenus** can be entered (chapter 7)

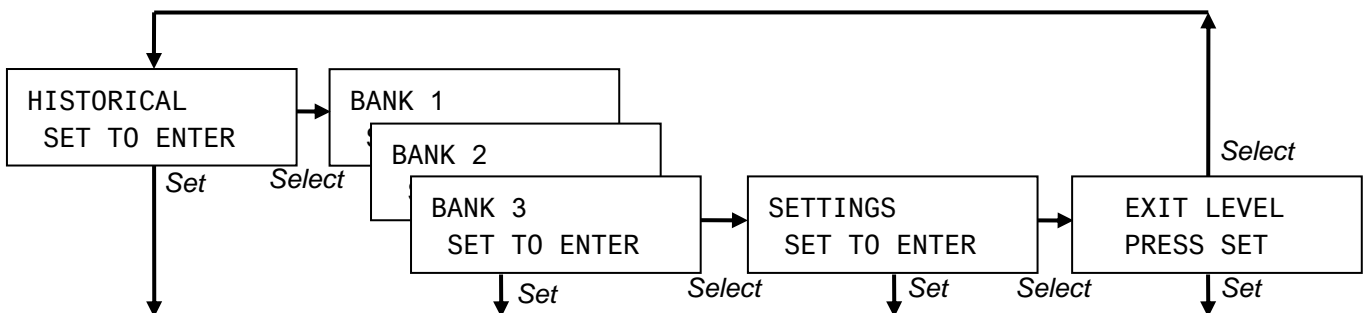

Historical data menu (see chapter 8).
This menu shows the history of your battery set(s)

Battery Bank menus (1, 2 and 3) (see chapter 9).
Used to adjust the Masterlink BTM-III in accordance with the specifications of each battery set and to adjust the trigger points for the alarm function of each battery set.

Settings menu (see chapter 10).
General settings like language, energy save mode and advanced settings for each battery bank. Here you can also to reset the Masterlink BTM III back to the factory settings

From here you can return to the main menu (see above) by pressing **Set** shortly.
Also if none of the buttons was touched for 40 seconds, the Masterlink BTM-III returns to the main menu.

NOTE: Displayed data may differ.